

# HT-Innenentwässerung

## Das komplette Programm. Einfache Steckmontage, deshalb schnell und sauber zu verlegen!

- Rohre und Formstücke für Abwasserleitungen innerhalb von Gebäuden nach DIN EN 1451 - 1
- heißwasserbeständig bis 90°C
- für heiße, kalte und aggressive Abwässer geeignet
- einfache Steckmuffen-Verbindung
- schnell und rationell zu verlegen mit geringem Gefälle
- Nennweiten DN 32/40/50/75/110
- Material: schwer entflammables Polypropylen = PP nach DIN 4102/B1
- Farbe: Staubgrau RAL 7037

### Toilette

Montage der Abwasserrohre unterhalb der Decke. Spülkasten nicht eingebaut.

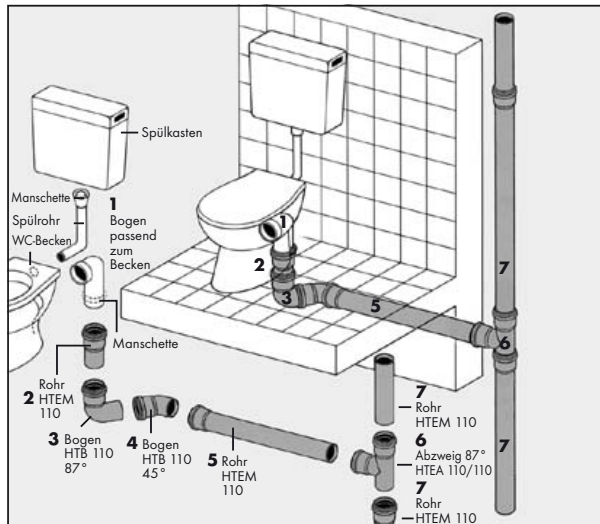

### Waschbecken

Verlegung der Abwasserrohre im Mauerschlitz. Anschluss unter der Decke.

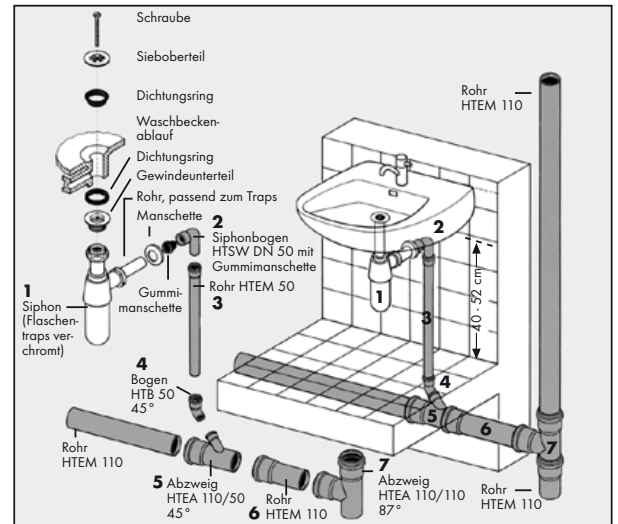

### Dusche

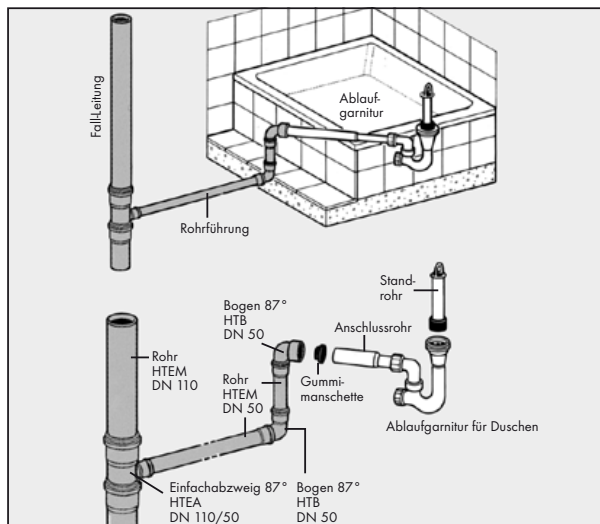

### Spüle und Geschirrspüler

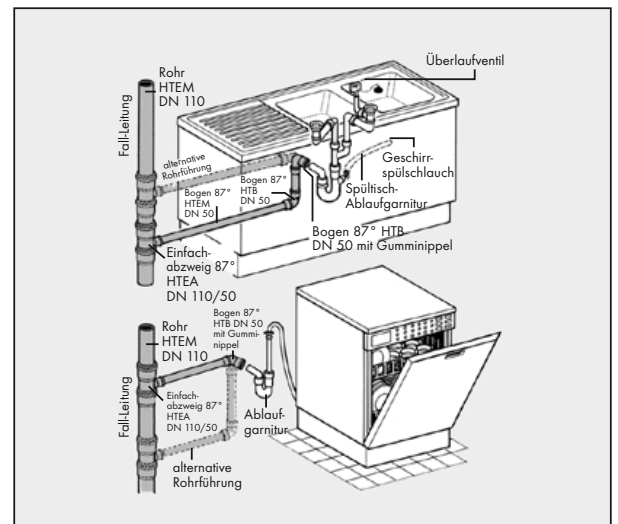









Einfach QR-Code abfotografieren und unseren Produktfilm **Marley HT-Rohrleitungssystem** auf Ihrem Smartphone ansehen!













Weitere Informationen unter **www.marley.de**













Mach's mit Marley.

# Marley HT-Innenentwässerung

Das HT-Programm zur einfachen Steckmontage.  
Mit vormontierter Lippendichtung.

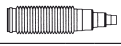
Artikel	DN	EAN-Nr. 4002644...	Menge
<b>HTEM Rohre mit Steckmuffe</b> 	150 mm	40	090023
		50	090030
		75	090047
	250 mm	110	090054
		32	090115
		40	090122
		50	090139
		75	090146
	500 mm	110	090153
		32	090214
		40	090221
		50	090238
		75	090245
	1000 mm	110	090252
		32	090412
		40	090429
50		090436	
75		090443	
2000 mm	110	090450	
	32	090818	
	40	090825	
	50	090832	
	75	090849	
<b>HTB Bogen 15°</b> 	110	090856	
	32	091105	
	40	091129	
	50	091136	
	75	091143	
<b>HTB Bogen 30°</b> 	110	091150	
	32	091204	
	40	091228	
	50	091235	
<b>HTB Bogen 45°</b> 	110	091242	
	32	091303	
	40	091327	
	50	091334	
<b>HTB Bogen 67°</b> 	110	091341	
	32	091358	
	40	091402	
	50	091426	
<b>HTB Bogen 87°</b> 	110	091433	
	32	091457	
	40	091426	
	50	091440	
<b>HTEA Einfach-Abzweig 45°</b> 	110	091457	
	32/32	091709	
	40/40	091716	
	50/40	091723	
	50/50	091730	
	75/50	091754	
	75/75	091761	
	110/50	091778	
110/75	091785		
<b>HTEA Einfach-Abzweig 67°</b> 	110/110	091792	
	40/40	091815	
	50/40	091822	
	50/50	091839	
	75/50	091853	
	75/75	091860	
	110/50	091877	
	110/75	091884	
<b>HTEA Einfach-Abzweig 87°</b> 	110/110	091891	
	32/32	091907	
	40/40	091914	
	50/40	091921	
	50/50	091938	
	75/50	091952	
	75/75	091969	
	110/50	091976	
110/75	091983		
110/110	091990		

Artikel	DN	EAN-Nr. 4002644...	Menge
<b>HTDA Doppel-Abzweig 67°</b> 	50/50/50	092126	
	75/75/75	092133	
	110/50/50	092140	
	110/110/110	092164	
	110/110/110	092171	
<b>HTED Eck-abzweig 67°</b> 	110/110/110	092171	
	40/32	092300	
	50/40	092324	
	75/50	092348	
	110/50	092355	
<b>HTR Übergangrohr exzentrisch</b> 	110/75	092362	
	110/50	513683	
<b>HTR Übergangrohr kurz exzentrisch</b> 	110/75	513690	
	40	092423	
<b>HTL Langmuffe (2 1/2 fach)</b> 	50	092430	
	75	092447	
	110	092454	
	32	092508	
<b>HTU Überschiebemuffe</b> 	40	092522	
	50	092539	
	75	092546	
	110	092553	
<b>HTRE Reinigungsrohr</b> 	50	092737	
	75	092744	
	110	092751	
<b>HTM Muffenstopfen</b> 	32	092805	
	40	092829	
	50	092836	
	75	092843	
<b>HTSW Siphon-Winkel 90°</b> 	110	092850	
	30/30	099293	
	40/30	092928	
	40/40	092935	
	50/40	092942	
<b>HTDSB Doppelsiphon-Bogen 90°</b> 	50/50	092959	
	40/50/40	092966	
	32/32	098791	
	40/40	093024	
	50/40	093031	
<b>HTS Anschlussstück am Metallrohr</b> 	50/50	093048	
	50	093352	
	75	093369	
<b>HTUG Anschlussstück an Gussrohre</b> 	110	093376	
	40	093628	
	50	093635	
<b>HT-Schelle, verzinkt</b> 	75	093642	
	110	093659	

Artikel	DN	EAN-Nr. 4002644...	Menge
<b>HT-Schelle, mit Gewindestift 8 x 80 mm</b> 	40	093666	
	50	093673	
	75	093680	
	110	093697	
<b>Gleitmittel</b>	150 ml	093963	
<b>HT-Schelle schalldämmend mit Stockschraube, 8 x 80 mm</b> 	40	093765	
	50	093772	
	75	093789	
	110	093796	
<b>HTGM, Gummimanschette für Siphonbogen 90°, Doppelsiphon und HTS</b> 	für NW 30/30	30/30	094632
	40/30 A	40/30 A	094649
	40/30 B	40/30 B	094656
	40/40 C	40/40 C	094663
	50/40	40/40 C	094663
	50/50	50/30 D	094670
<b>Gumminippel mit Sickenwulst für Metall- oder Bleirohre</b> 	50/40 E	50/40 E	094687
	50/50 F	50/50 F	094694
	40 - 1 1/4"	40 - 1 1/4"	094700
<b>Doppeldichtung für Muffen</b> 	50	094731	
	75	094748	
	110	094755	
<b>Ersatz-Dichtring</b> 	32	094809	
	40	094762	
	50	094779	
	75	094786	
	110	094793	
<b>HT-Flexschlauch</b> 	250 mm	50	093918
	500 mm	50	093925
	750 mm	50	093932
	1000 mm	50	093949
<b>HT-Rohrbelüfter</b> 	32/40/50	093833	
	75/110	093840	
<b>Dunstrohranschluss</b> 	50/75/110	093901	
<b>HT-Innenreduktion zum Anschluss von HT-Rohren DN 50 und 75 an Rohrenden DN 110.</b> 	110-50	092614	
	110-75	092621	
<b>Rohrverbinder</b> 	24-32/32-40	338064	
	24-32/42-50	338071	
	32-40/42-50	338187	
	42-50/50-63	338286	
	42-50/75-89	338293	
	42-50/100-115	338309	
	75-89/110-115	338101	
	100-115/110-125	338156	
	110-115/121-136	338149	
	110-125/144-160	338163	
<b>Übergang</b> 	24-32	338088	
	32-40	338194	
	42-50	338316	
	55-65	338118	
	75-89	338231	
	110-115	338262	
<b>Kupplung</b> 	24-32	338088	
	32-40	338194	
	42-50	338316	
	55-65	338118	
	75-89	338231	